





H series

EXCELLENCE IN POSITIONING

2.5 H SERIES

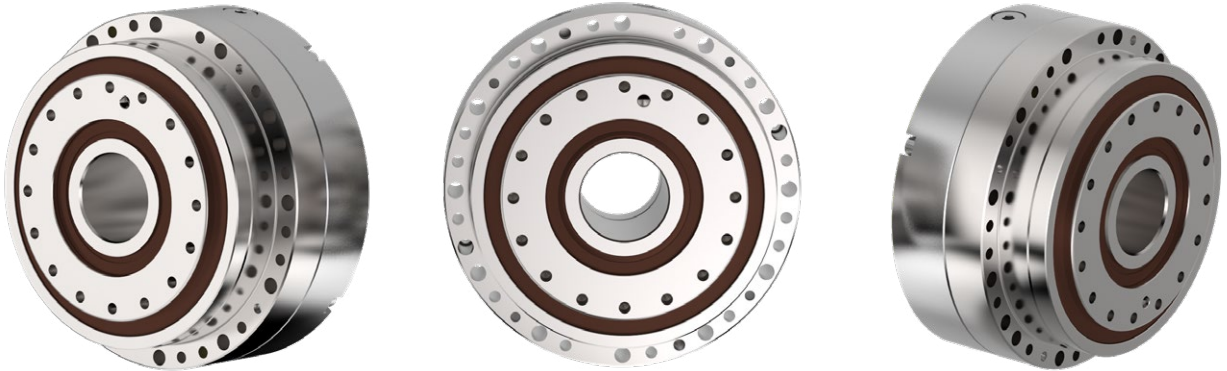

Advantages

- large input shaft hole diameter
- fully sealed
- zero-backlash reduction gears
- high moment capacity
- excellent positioning accuracy and positioning repeatability
- high torsional and tilting stiffness
- small dimensions and low weight
- high reduction ratios
- high efficiency
- long lifetime
- easy assembly

The **H series** represents TwinSpin® high precision reduction gears with through-holes in the shafts, also known as the hollow-shaft version. Cables, tubes with compressed air, drive shafts etc. can be led through the hole in the shaft of the gear. The H series is completely sealed and filled with grease for lifetime. The H series high precision reduction gears comprise an accurate reduction mechanism and high-capacity radial and axial cylindrical bearings. This design of the reduction gears allows the load mounting directly on the output flange or case without the need for additional bearings.

Tab. 2.5a: H series features

Case	Threaded and through holes in the case
Input flange connection	Completely sealed reduction gear
Input shaft design*	Input shaft is offered in the following versions: a) hollow shaft b) according to special request
Installation and operation characteristics	Hollow-shaft reduction gears. Large hole in the input shaft allows cables, tubes or an additional shaft to pass through the reduction gear. Suitable for applications where the input shaft rotation is achieved by using a tooth belt or similar arrangement.

*On request

Tab. 2.5b: H series ordering specifications

TS - 200 - 125 - H - H52					
Name	Size	Ratio	Series version	Shaft version	
				H	S ¹⁾
TS	70	75	H	13	•
	140	69, 115	H	36	•
	170	69, 125	H	42, 46	•
	200	63, 125	H	52, 56	•
	220	55, 125	H	62, 65	•

H series

Note: Example of the ordering code of the modified H series TwinSpin® reduction gear with a motor flange:
 TS200 - 125 -H- H56 - M235 - P231. The marks M235 and P231 for specific modification are defined by the manufacturer.
 1) Upon request

Shaft version

H

Hollow shaft

S

Special shaft

Tab. 2.5c: H series rating table

Size	Reduction ratio	Shaft inside diameter	Rated output torque	Max. acceleration / deceleration torque	Permissible output torque at emergency stop	Rated input speed	Max. allowable input speed 9)	Tilting stiffness 1) 5)	Torsional stiffness 1) 6)	Max. no-load starting torque 8)	Max. back driving torque 8)
	i	d	T _R [Nm]	T _{acc} [Nm]	T _{em} [Nm]	n _R [rpm]	n _{max} [rpm]	M _t [Nm/arcmin]	k _t [Nm/arcmin]	[Nm]	[Nm]
TS 70	75	13	50	100	250	2 000	5 500	35	7.5	0.22	13
TS 140	69	36	200	500	1 000	2 000	3 500	340	55	1.6	110
	115						4 500			1.5	130
TS 170	69	42	420	1 050	2 100	2 000	3 200	1 100	110	2.5	180
		46		825	1 650						
	125	42		1 050	2 100		3 700			2.2	240
		46		825	1 650						
TS 200	63	52	712	1 780	3 560	2 000	2 700	2 000	200	4	250
		56		1 100	2 200						
	125	52		1 780	3 560		3 700			3	300
		56		1 100	2 200						
TS 220	55	62	1 100	2 750	5 500	2 000	2 400	2 400	290	5	170
		65		2 000	4 000						
	125	62		2 750	5 500		3 400			3	350
		65		2 000	4 000						

RIGHT TO CHANGE WITHOUT PRIOR NOTICE RESERVED

- 1) Mean statistical value. For further information see chapter Torsional stiffness, Tilting stiffness.
- 2) Load at output speed 15 rpm.
- 3) Moment $M_{c,max}$ value for $F_a=0$. If $F_a \neq 0$, see chapter 3.5.
- 4) Axial force F_a max value for $M_c=0$. If $M_c \neq 0$, see chapter 3.5.
- 5) The parameter depends on the high precision reduction gear version.
- 6) The parameter depends on the version of the high precision reduction gear, ratio and lost motion.
- 7) The parameter values are informative. Exact value depends on specific version of the high precision reduction gear.
- 8) Temperatures of the high precision reduction gear below 20°C will cause higher no-load starting or back driving torque.
- 9) Instantaneous speed peak that may occur within the working cycle.

Tab. 2.5c: H series rating table - continued

Size	Reduction ratio	Max. lost motion	Average angular transmission error 1) 6)	Hysteresis	Max. moment 2) 3)	Rated radial force 2)	Max. axial force 2) 4)	Input inertia 7)	Weight 7)
	i	LM [arcmin]	ATE [arcsec]	H [arcmin]	$M_{c\ max}$ [Nm]	F_{r} [kN]	$F_{a\ max}$ [kN]	I [10^{-4} kgm ²]	m [kg]
TS 70	75	<1.5	±30	<1.5	142	2.8	4.1	0.061	1
TS 140	69	<1.5	±17	<1.0	1 160	11.5	17	3.6	7.5
	115								
TS 170	69	<1.0	±17	<1.0	2 000	19.2	27.9	4.8	11.6
	125								
TS 200	63	<1.0	±15	<1.0	3 300	21.5	31.7	18.2	20
	125								
TS 220	55	<1.0	±15	<1.0	4 400	22.5	35.5	31	26
	125								

IMPORTANT NOTES:

- Instantaneous speed peak that may occur within the working cycle.
- Note please the temperature on the gear case that should not exceed 60°C.
- Load values in the table are valid for the nominal life of $L_{10} = 6\ 000$ [Hrs].
- High precision reduction gears are preferred for intermittent cycles (S3-S8); the output speed in applications is an inverted-variable. Continuous mode cycle (S1) should be consulted with the manufacturer.
- Please consult maximum speed in a duty cycle with the manufacturer.
- Values in the table refer to nominal operating temperature.

The ratios highlighted in bold are recommended by SPINEA® as optimal versions in terms of price and delivery.

TS 170 - i - H - H46

INPUT SIDE VIEW

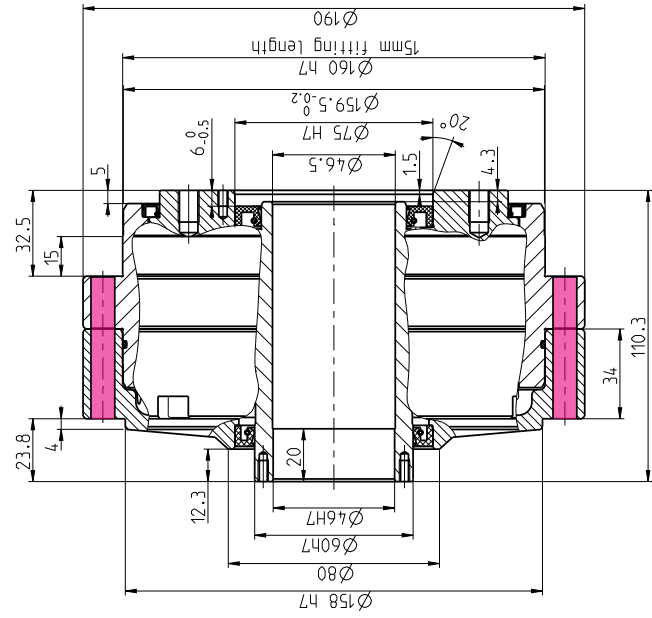
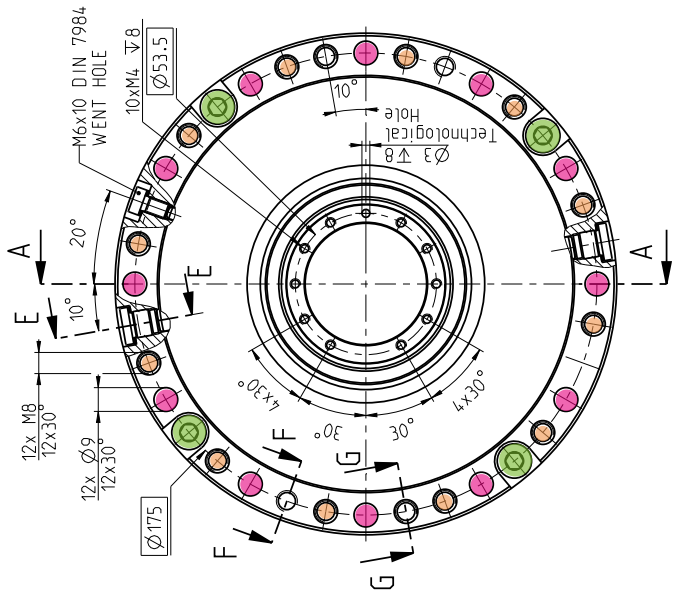

TS 170 - i - H - H46

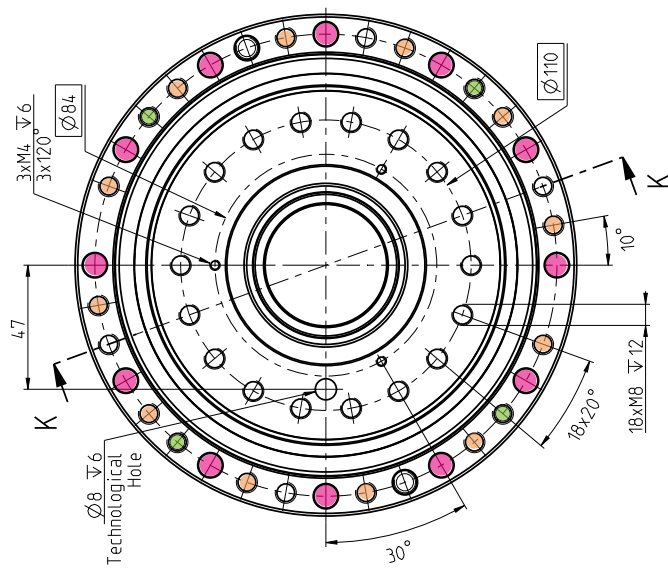

A-A

K-K

G-G

F-F

E-E

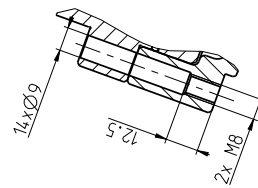
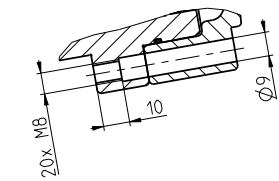
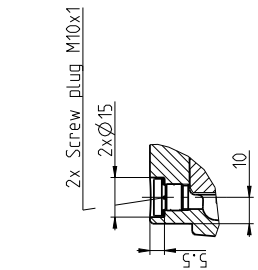
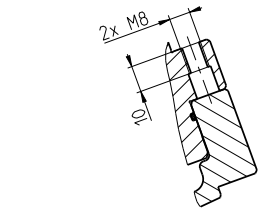

1. Use only standardized components, such as ring seals, bolts, etc.
2. Right to change without prior notice reserved.

TS 220 - i - H - H 65

INPUT SIDE VIEW

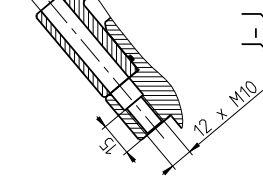
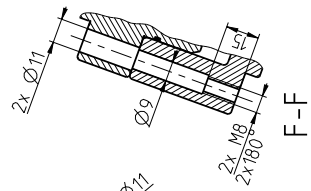
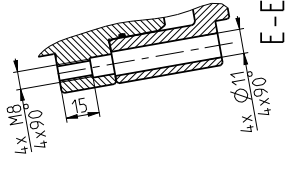
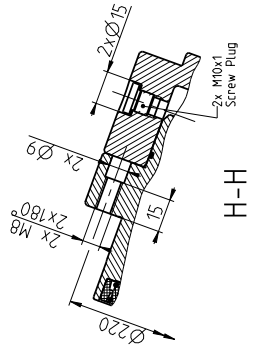
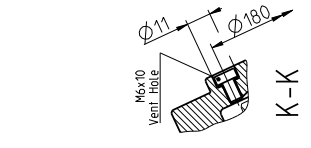
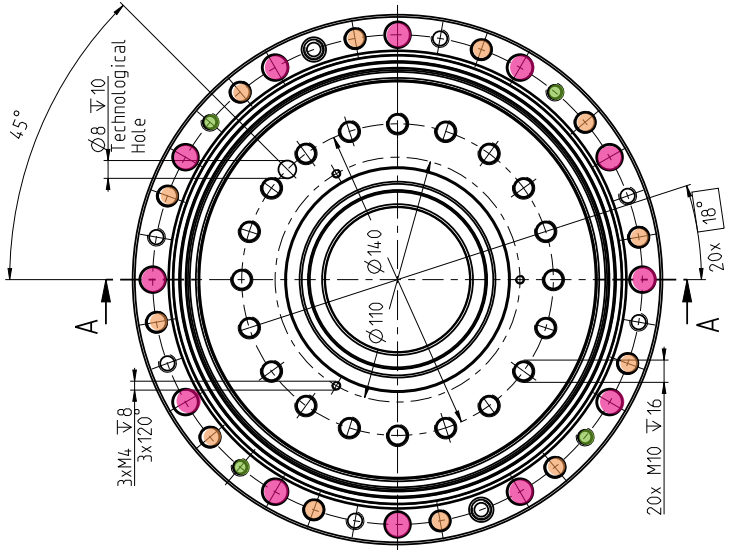
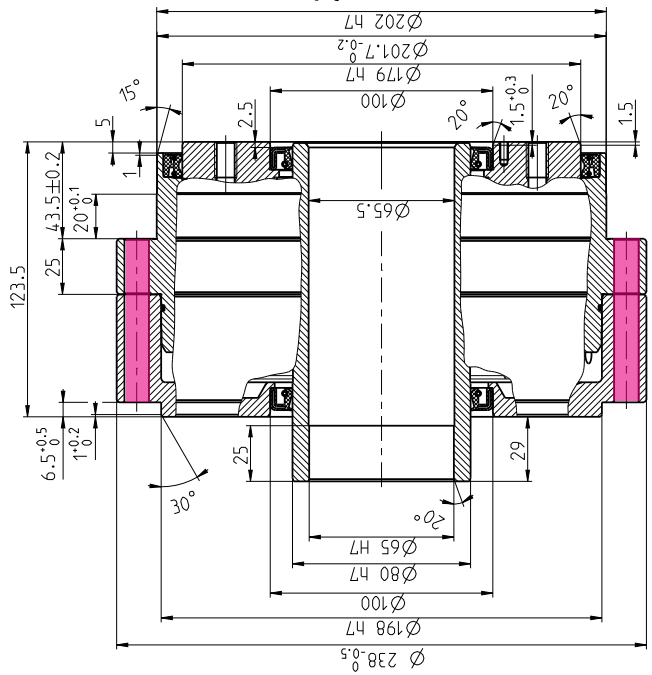
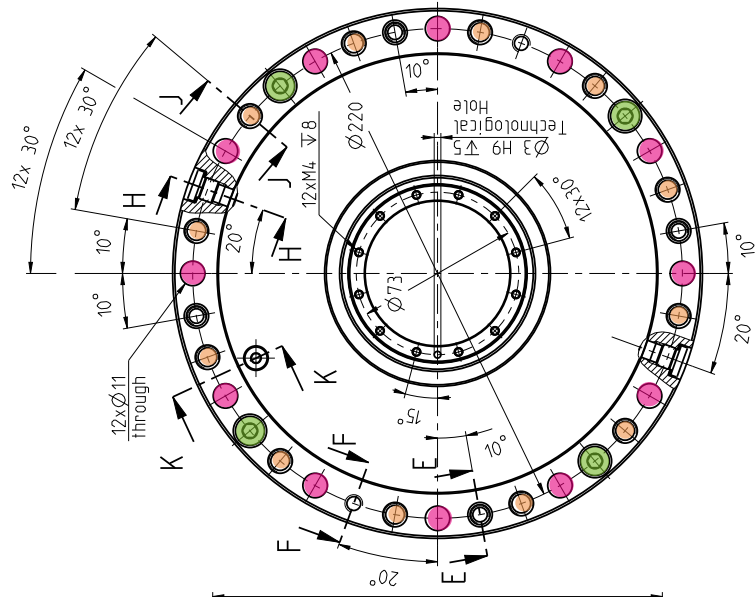

1. Use only standardized components, such as ring seals, bolts, etc.
2. Right to change without prior notice reserved.